

# SURGICAL SUCTION & SURGICAL ACCESSORIES

---

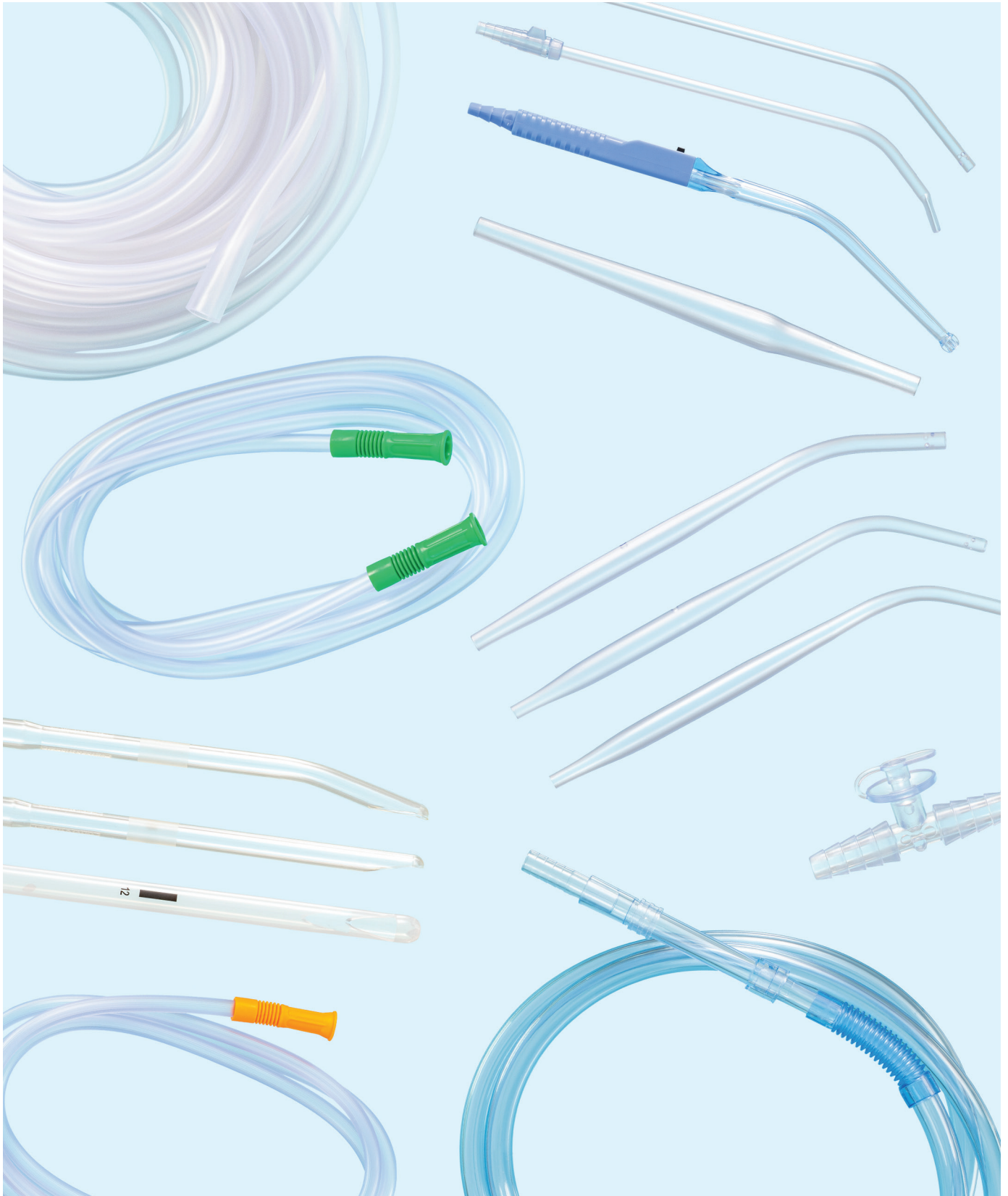

# CONTENTS

<b>About Pennine</b>	3
<b>Pennine Surgical Suction Range</b>	4
<b>Suction Connecting Tubing</b>	
Suction Connecting Tubing	5
Soft Suction Connecting Tubing	7
Flexi-Rib Tubing	8
Tubing with Capped Vacuum Control	9
Capped Vacuum Control Connector	9
Tubing Connector Rigid	10
Link Suction Connecting Tubing	11
Link Suction Connecting Tubing (Bubble Tubing)	12
<b>Suction Devices</b>	
Link Yankauers	13
Link Yankauer Sets	15
Derby Yankauers	16
Selectovac Yankauers	16
Poole Suction Probes	17
Poole Suction Probe Sets	18
<b>Suction Probes</b>	
Suction Probes	19
Suction Probe Sets	20
Micro-Flex Suction Probes	21
Endo-Flex Suction Probes	22
Frazier Probes	23
<b>Easyflow Orthopaedic Suction Set</b>	24
<b>Uterine Aspiration Curette System</b>	
Flexible Uterine Curettes	25
Uterine Aspiration Curettes	26
Wide-Bore Aspiration Tubing (Flexi-Cuff)	27
<b>Accessories</b>	
Camera Drape	28
C-Arm Drape	29



## ABOUT PENNINE

Pennine Healthcare is proud to be one of the UK's leading, employee owned, manufacturer and distributor, of single use, sterile Ward & Theatre Consumables and Custom Procedure Packs, and since our incorporation in 1963, the business has grown year on year. We market our products and services in over 50 countries worldwide and employ around 200 people at our purpose-built premises in Derby.

In line with our ISO 13485 accreditation, Pennine has a policy of continual improvement in order to meet the needs of the changing global standards for sterile, single use medical devices. Continual investment in people, training, and technology, has enabled us to provide an increasingly wide range of user friendly, high specification products. We also promote standards of safety, health, and welfare to provide a healthy and safe working environment.

Our vision will be delivered by supplying world class products and delivering distinctive customer service supported by a culture of continuous

improvement and investing in our people. Our core skills in manufacturing and engineering make us competitive through technological innovation, enabling us to be innovative, flexible and responsive, supplying healthcare organisations and businesses across the globe with the highest quality British manufactured products.

Pennine Healthcare is also proud to be one of the leading suppliers of PPE into healthcare settings, and as a hospital focussed company, we sell directly to healthcare professionals in all areas, including intensive care and operating theatres. In 2014 Pennine Healthcare saw the need to develop a range of PPE and Infection Control products, due to a lack of complete, high quality products available for the general public, and thus ARMA was born.

We hope you find what you are looking for in the following pages of this brochure, but if you do not, please do not hesitate to get in touch. We're a friendly bunch and love speaking to new, and old, customers alike.

# PENNINE SURGICAL SUCTION RANGE

Our Surgical Suction Range offers superb quality, performance, and solution, to your surgical suction needs.

We strive to achieve the following in our Surgical Suction Range:

## CHOICE

Whether you are looking for tubing, suction devices, probes, or more, our product range offers a variety of products in a range of lengths, diameters and connectors, to fulfil yours and your patients needs and requirements.



## SPEED

Our Surgical Suction Range includes colour coding, for easy size identification, whilst certain products are provided in easy to open packaging.



## SAFETY

All of our products are Latex and DEHP free as standard, putting patient safety and the forefront of everything we manufacture.

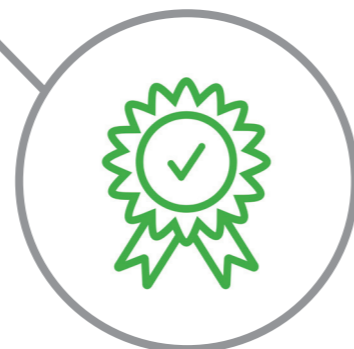

In line with our ISO 13485 accreditation, Pennine has a policy of continual improvement in order to meet the needs of the changing international standards for sterile, single use medical devices.

## SUCTION CONNECTING TUBING

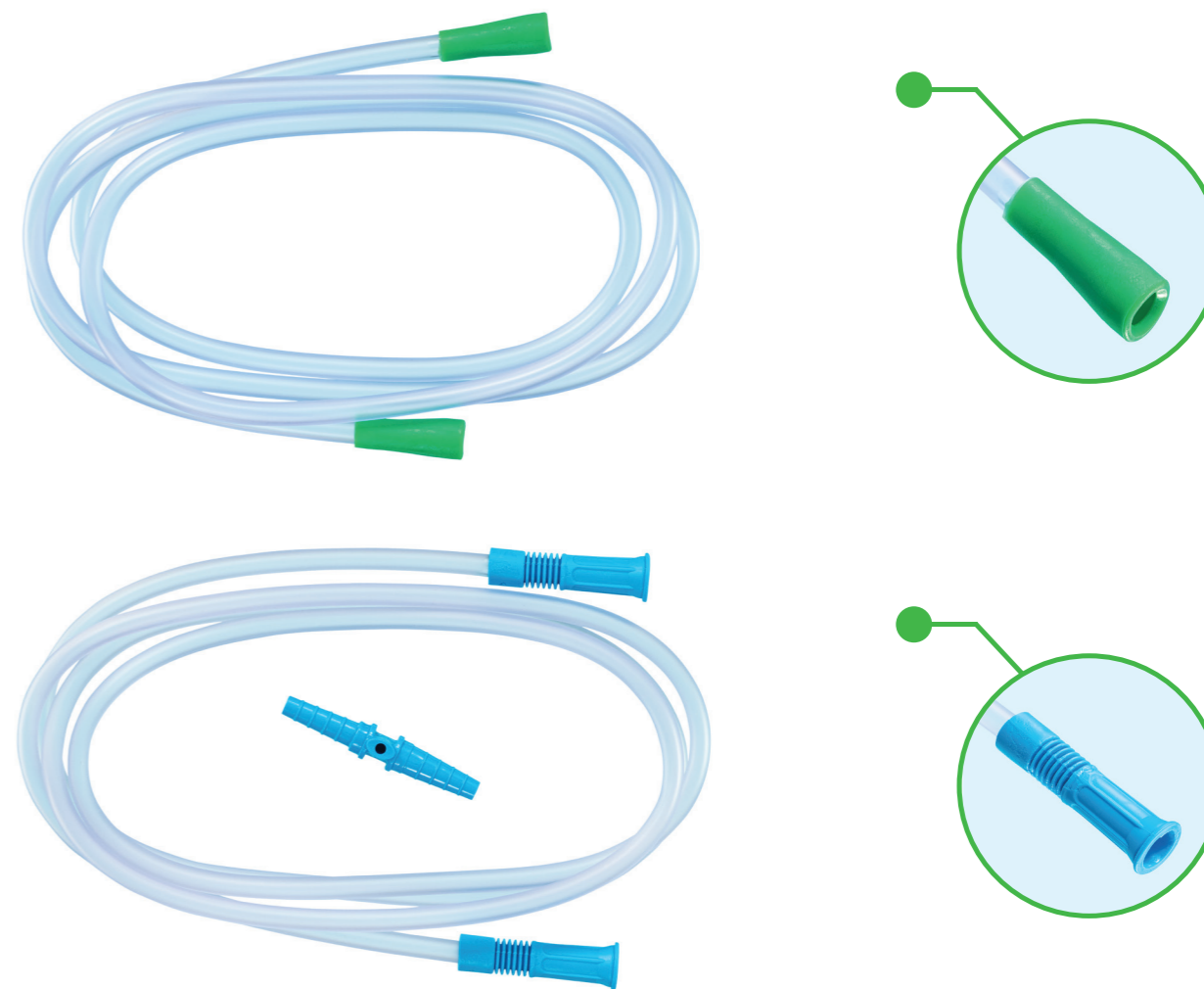

Our Suction Connecting Tubing is a complete system to connect suction sources to suction waste collection systems, suction catheters, yankauers, suction probes and other suction devices. The full Pennine range offers easily connected, interchangeable tubing, in a variety of lengths and diameters.

- Sterile double wrapped individual peel pouches
- Colour coded funnel connector to denote tube size
- 'F' Funnel connector fits suction machines and male tapered connections for instrumentation
- 'M' (Male) connector push fits into the 'F' connector and is normally used to connect to the standard funnel fitted on suction catheters. Can also be used to connect lengths of tubing together for longer lengths
- Application of 'M' connector with 'VC' (vacuum control) vent converts a standard catheter to vacuum control application



Want more information?  
Get in touch on +44 (0) 1332 794880 or email [customer.services@penninehealthcare.co.uk](mailto:customer.services@penninehealthcare.co.uk)

Please note: All dimensions are nominal.  
Please note any products featuring a "\*" indicates the product is distributed by Pennine.  
For Regulatory and Technical information, Technical Data Sheets, are available upon request.

Product Code	Type	Length	CH	Inside Diam. mm	Qty per Box
CT-4311	F/M	1.8m	24CH	5	25
CT-4312	F/F	1.8m	24CH	5	25
CT-4332	F/F	3.0m	24CH	5	20
CT-4335	F/F	3.0m	24CH	5	50
CT-4362	F/F	2.7m	24CH	5	20
CT-4372	F/F	3.5m	24CH	5	20
CT-4314	F/F/M	1.8m	24CH	5	25
CT-4364	F/F/M	2.7m	24CH	5	20
CT-4334	F/F/M	3.0m	24CH	5	20
CT-4374	F/F/M	3.5m	24CH	5	20
CT-4314/VC	F/F/M/VC	1.8m	24CH	5	25
CT-4324/VC	F/F/M/VC	2.0m	24CH	5	25
CT-4334/VC	F/F/M/VC	3.0m	24CH	5	20
CT-4354/VC	F/F/M VC	1.5m	24CH	5	25
CT-4394/VC	F/F/M/VC	2.7m	24CH	5	20
CT-4012	F/F	1.8m	26CH	6	25
CT-4022	F/F	2.0m	26CH	6	25
CT-4042	F/F	2.7m	26CH	6	20
CT-4032	F/F	3.0m	26CH	6	20
CT-4072	F/F	3.5m	26CH	6	20
CT-4092	F/F	4.0m	26CH	6	15
CT-4062	F/F	6.0m	26CH	6	10
CT-4020	F/open end	2.0m	26CH	6	25
CT-4030	F/open end	3.0m	26CH	6	20
CT-4014	F/F/M	1.8m	26CH	6	25
CT-4024	F/F/M	2.0m	26CH	6	25
CT-4044	F/F/M	2.7m	26CH	6	20
CT-4034	F/F/M	3.0m	26CH	6	20
CT-4074	F/F/M	3.5m	26CH	6	20
CT-4064	F/F/M	6.0m	26CH	6	10
CT-4014/VC	F/F/M/VC	1.8m	26CH	6	25
CT-4024/VC	F/F/M/VC	2.0m	26CH	6	25
CT-4034/VC	F/F/M/VC	3.0m	26CH	6	20
CT-4622	F/F	2.0m	30CH	8	10
CT-4632	F/F	3.0m	30CH	8	10
CT-4672	F/F	3.5m	30CH	8	10
CT-4642	F/F	4.0m	30CH	8	10
CT-4624	F/F/M	2.0m	30CH	8	10
CT-4634	F/F/M	3.0m	30CH	8	10
CT-4674	F/F/M	3.5m	30CH	8	10
CT-4634/VC	F/F/M/VC	3.0m	30CH	8	10

## SOFT SUCTION CONNECTING TUBING

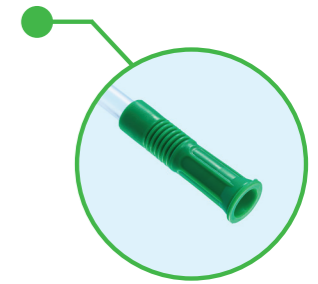
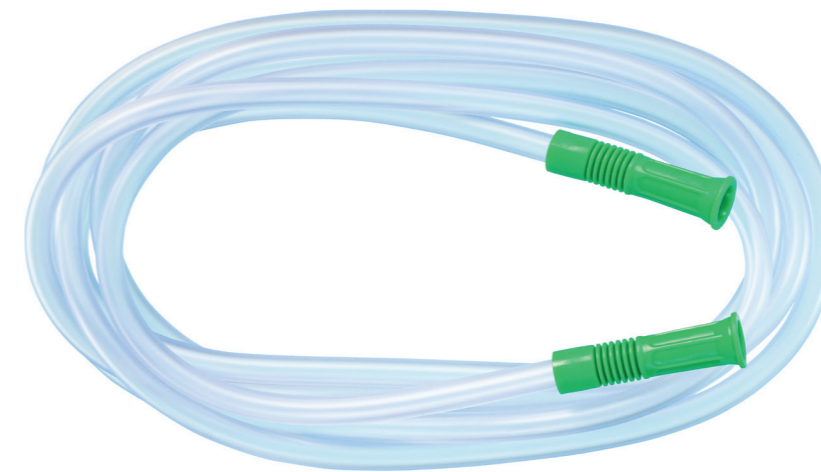

Our Soft Suction Connecting Tubing is used to connect suction sources to suction waste collection systems, suction catheters, yankauers, suction probes and other suction devices.

- Softer PVC grade tubing for enhanced drapability
- Available in 5mm, 6mm and 8mm (internal diameter)
- Sterile double wrapped individual peel pouches
- Tested up to 0.6 bar pressure
- Colour coded funnel connector to denote tube size

Product Code	Type	Length	CH	Inside Diam. mm	Qty per Box
CTS-4332	F/F	3.0m	24CH	5	20
CTS-4022	F/F	2.0m	26CH	6	25
CTS-4032	F/F	3.0m	26CH	6	20
CTS-4072	F/F	3.5m	26CH	6	20
CTS-4092	F/F	4.0m	26CH	6	15
CTS-4640/R	F/open end	4.0m	30CH	8	10



Want more information?  
Get in touch on +44 (0) 1332 794880 or email [customer.services@penninehealthcare.co.uk](mailto:customer.services@penninehealthcare.co.uk)



We're here to help, please get in touch via telephone on +44 (0) 1332 794880 or email us at [customer.services@penninehealthcare.co.uk](mailto:customer.services@penninehealthcare.co.uk)

## FLEXI-RIB TUBING

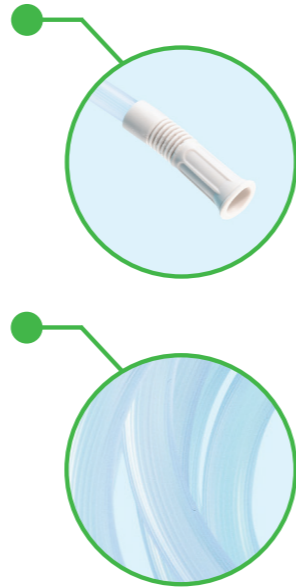
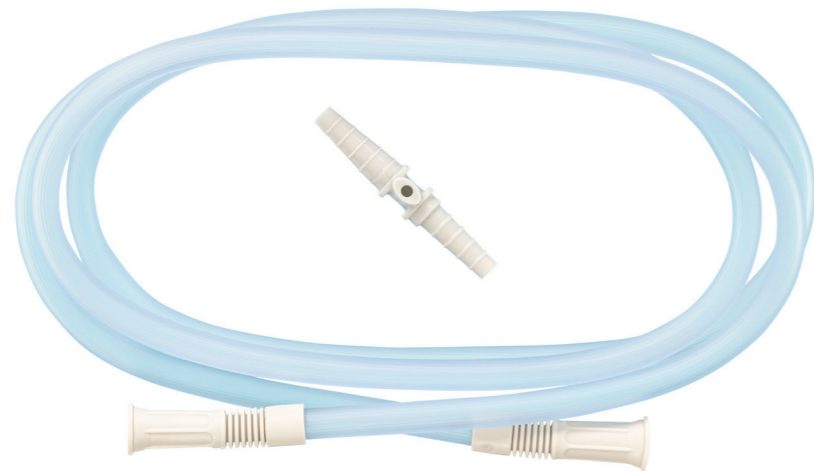

Our Flexi-Rib Tubing is used to connect suction sources to suction waste collection systems, suction catheters, yankauers, suction probes and other suction devices.

- Ribbed connecting tubing for enhanced drapability
- Resistant to kinking
- Economical box size
- Colour coded funnel connector to denote tube size
- Sterile double wrapped individual peel pouches

Product Code	Type	Length	CH	Inside Diam. mm	Qty per Box
CT-4922	F/F	2.0m	26CH	6	60
CT-4932	F/F	3.0m	26CH	6	50
CT-4972	F/F	3.5m	26CH	6	50
CT-4924	F/F/M	2.0m	26CH	6	60
CT-4934	F/F/M	3.0m	26CH	6	50
CT-4722	F/F	2.0m	28CH	7	60
CT-4732	F/F	3.0m	28CH	7	50
CT-4772	F/F	3.5m	28CH	7	40
CT-4734	F/F/M	3.0m	28CH	7	50
CT-4774	F/F/M	3.5m	28CH	7	40
CT-4714/VC	F/F/M/VC	1.8m	28CH	7	25
CT-4741/VC	F/F/M/VC	2.5m	28CH	7	20

## TUBING WITH CAPPED VACUUM CONTROL

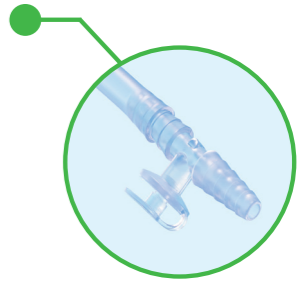
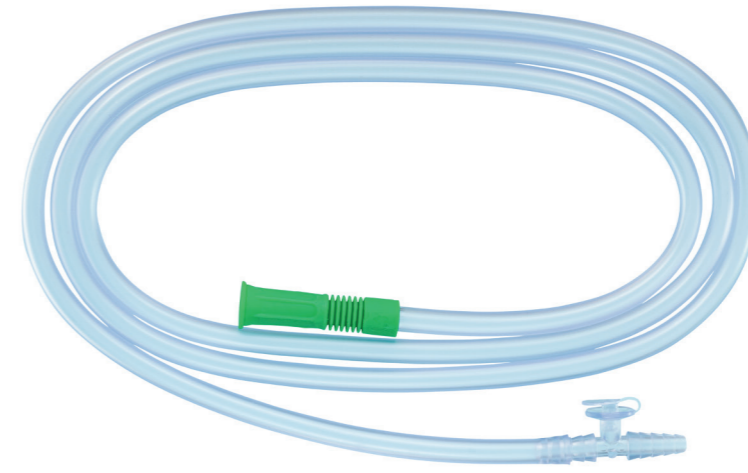

- Sterile double wrapped individual peel pouches

Product Code	Type	Length	CH	Inside Diam. mm	Qty per Box
CT-4015	F/VCU2	1.8m	26CH	6	25
CT-4025	F/VCU2	2.0m	26CH	6	25

## CAPPED VACUUM CONTROL CONNECTOR

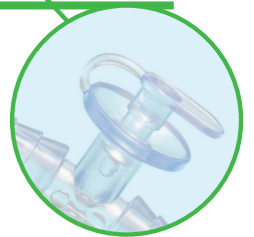
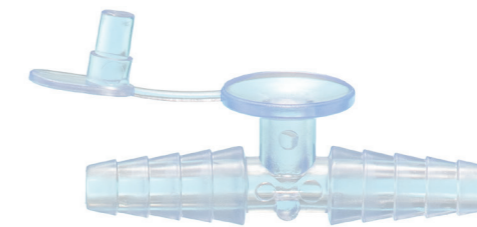

This Capped Vacuum Control Connector is capped for ease of use to convert a standard suction device into a vacuum controlled suction device. Available sterile and bulk non-sterile.

Product Code	Type	Qty per Box
VCU-2	Sterile	100
VC-2/Bulk	Bulk, non sterile	1200



For more information on our product range please contact us on +44 (0) 1332 794880 or alternatively send an email to [customer.services@penninehealthcare.co.uk](mailto:customer.services@penninehealthcare.co.uk)



Want more information?  
Get in touch on +44 (0) 1332 794880 or email [customer.services@penninehealthcare.co.uk](mailto:customer.services@penninehealthcare.co.uk)

## TUBING CONNECTOR RIGID

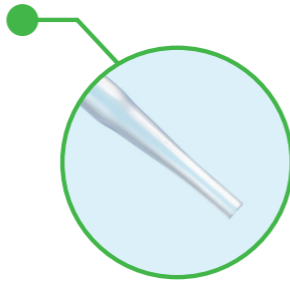

This Tubing Connector Rigid can be used to extend length of tubing, of either the same or different diameters.

- Clear PVC, single use only
- Available sterile and bulk non-sterile
- Designed for use with all types of tubing

Product Code	Type	Qty per Box
DP-501	Sterile	100
DP-501/Bulk	Bulk, non sterile	500

## LINK SUCTION CONNECTING TUBING

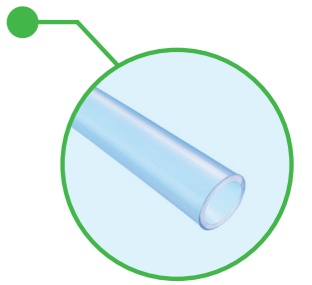
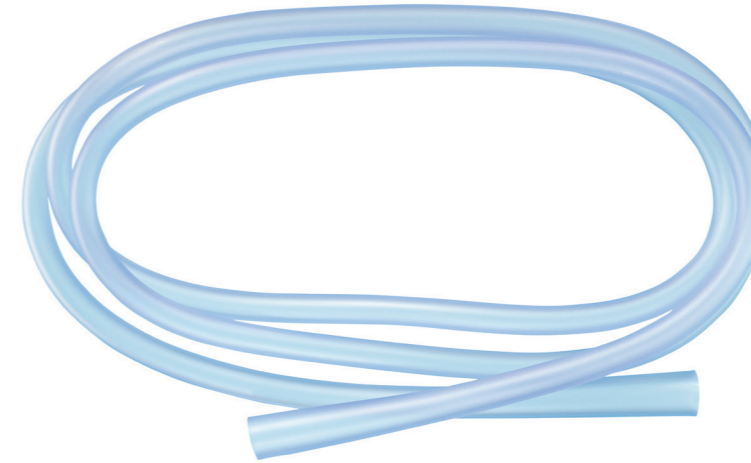

The Pennine Link tubing is used for connecting suction sources to suction waste collection systems, suction catheters, yankauers, suction probes and other suction devices. Tubing has an integral female funnel and a tapered male end to provide adaptable connections.

- Sterile double wrapped individual peel pouches
- Disposable PVC tubing
- Available in two diameters, 5mm & 7mm

Product Code	Type	Length	CH	Inside Diam. mm	Qty per Box
CT-4513	Plain F/F	1.8m	24CH	5mm	25
CT-4543	Plain F/F	2.7m	24CH	5mm	20
CT-4511	Plain M/F	1.8m	24CH	5mm	25
CT-4541	Plain M/F	2.7m	24CH	5mm	20
CT-4713	Plain F/F	1.8m	28CH	7mm	25
CT-4783	Plain F/F	3.7m	28CH	7mm	20
CT-4741	Plain M/F	2.7m	28CH	7mm	20
CT-4743	Plain F/F	2.7m	28CH	7mm	20
CT-4711	Plain M/F	1.8m	28CH	7mm	25



We're here to help, please get in touch via telephone on +44 (0) 1332 794880 or email us at [customer.services@penninehealthcare.co.uk](mailto:customer.services@penninehealthcare.co.uk)



For more information on our product range please contact us on +44 (0) 1332 794880 or alternatively send an email to [customer.services@penninehealthcare.co.uk](mailto:customer.services@penninehealthcare.co.uk)

## LINK CONNECTING TUBING (BUBBLE TUBING)

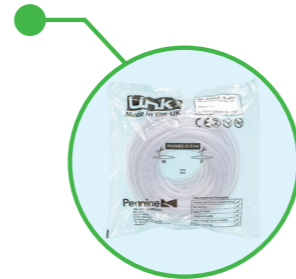
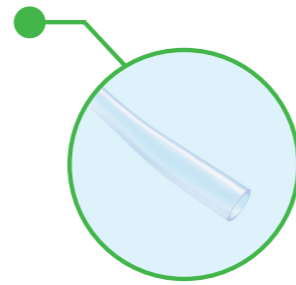
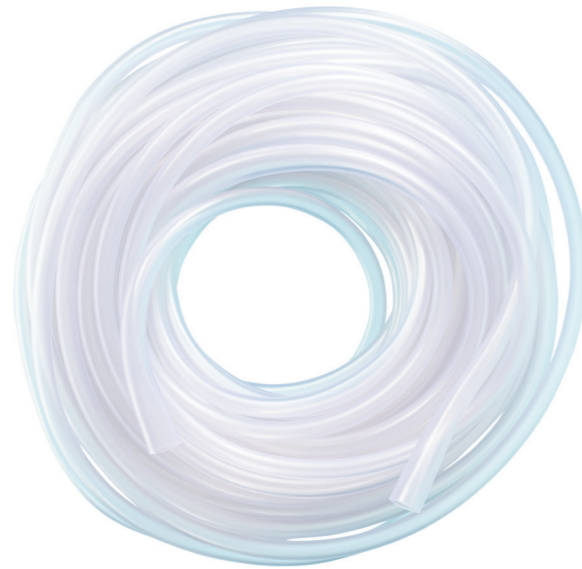

Our Link Connecting Tubing (Bubble Tubing) is available non-sterile and in 30 and 50 metre lengths, three diameters: 5mm, 6mm and 7mm supplied in convenient dispenser bags. Tube extruded with a bubble at approximately 1m intervals. Simply cut through the bubble at the required length to create either a male or female end to fit a range of suction devices.

Product Code	Type	Length	CH	Inside Diam. mm	Qty per Box
SL-8005	Plain	30m	24CH	5mm	8
SL-8055	Plain	50m	24CH	5mm	4
SL-8056	Plain	50m	26CH	6mm	4
SL-8007	Plain	30m	28CH	7mm	7

## LINK YANKAUERS

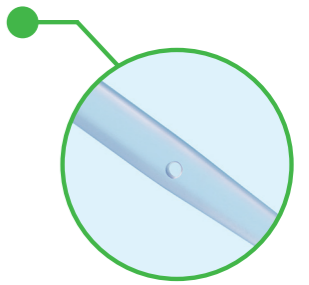
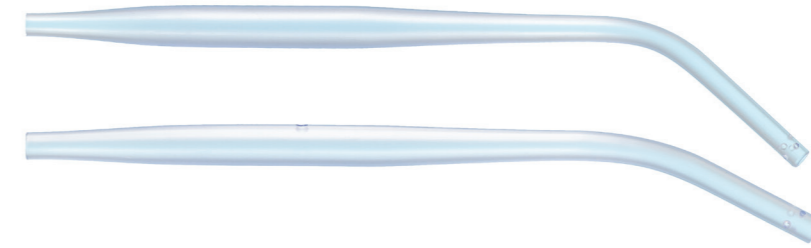

Our Link Yankauers are rigid, transparent suction devices for use with suction connecting tubing. For general purpose and fine suctioning, as well as suction of large volumes. Also available as a set, pre-attached to 2 or 3 metre tubing.

- Sterile double wrapped in individual peel pouches
- Available with or without VC (vacuum control) vent
- Short mini, Mini fine, Midi and Maxi Yankauers available with smooth rounded end or Super Tip
- Midi Yankauer available with additional Atraumatic Tip to reduce tissue grab

Product Code	Type	Length	CH	Qty per Box
LY-3400	Short Mini Tip	190mm	15CH	100
LY-3401	Short Mini Tip VC	190mm	15CH	100
LY-4400	Short Mini Super Tip	195mm	15CH	100
LY-4401	Short Mini Super Tip VC	195mm	15CH	100
LY-4420	Short Mini Super Tip (2 side)	195mm	15CH	100
LY-3500	Mini Fine Tip	255mm	12CH	50
LY-3501	Mini Fine Tip VC	255mm	12CH	50
LY-4500	Mini Fine Super Tip	255mm	12CH	50
LY-4501	Mini Fine Super Tip VC	255mm	12CH	50
LY-4501/NL	Mini Fine Super Tip VC	255mm	12CH	50
LY-3600	Midi Tip	240mm	18CH	50
LY-3601	Midi Tip VC	240mm	18CH	50
LY-3600/PR	Midi Tip	240mm	18CH	50
LY-4600	Midi Super Tip	240mm	18CH	50
LY-4600/PR	Midi Super Tip	240mm	18CH	50
LY-4601	Midi Super Tip VC	240mm	18CH	50
LY-3700	Maxi Tip	275mm	22CH	50
LY-3700/F	Maxi Tip (with blue connector)	315mm	22CH	50
LY-3700/RF/FF	Maxi Tip (with straight connector)	315mm	22CH	50
LY-3701	Maxi Tip VC	275mm	22CH	50
LY-3702	Maxi Tip (No side eyes)	275mm	22CH	50
LY-4700	Maxi Super Tip	275mm	22CH	50
LY-4700/PR	Maxi Super Tip	275mm	22CH	50
LY-4701	Maxi Super Tip VC	275mm	22CH	50



We're here to help, please get in touch via telephone on +44 (0) 1332 794880 or email us at [customer.services@penninehealthcare.co.uk](mailto:customer.services@penninehealthcare.co.uk)



We're here to help, please get in touch via telephone on +44 (0) 1332 794880 or email us at [customer.services@penninehealthcare.co.uk](mailto:customer.services@penninehealthcare.co.uk)

## LINK YANKAUERS (CONTINUED)

Product Code	Type	Length	CH	Qty per Box
LY-3800	Maxi Plus Tip	280mm	28CH	50
LY-3801	Maxi Plus Tip VC	280mm	28CH	50
LY-3803	Maxi Plus Tip VC (No side eyes)	280mm	28CH	50
* AELY3602	Atraumatic tip, soft short	255mm	18CH	50
* AELY3603	Atraumatic tip, soft short, VC	255mm	18CH	50
* AELY3606	Atraumatic tip, short rigid	255mm	18CH	50
* AELY3607	Atraumatic tip, short rigid, VC	255mm	18CH	50
* AELY3608	Atraumatic tip, long soft	263mm	18CH	50
* AELY3609	Atraumatic tip, long soft, VC	263mm	18CH	50

## LINK YANKAUER SETS

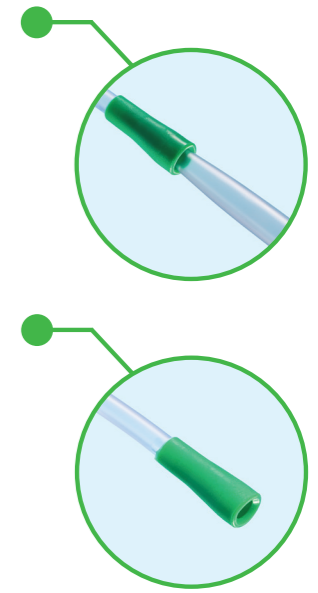
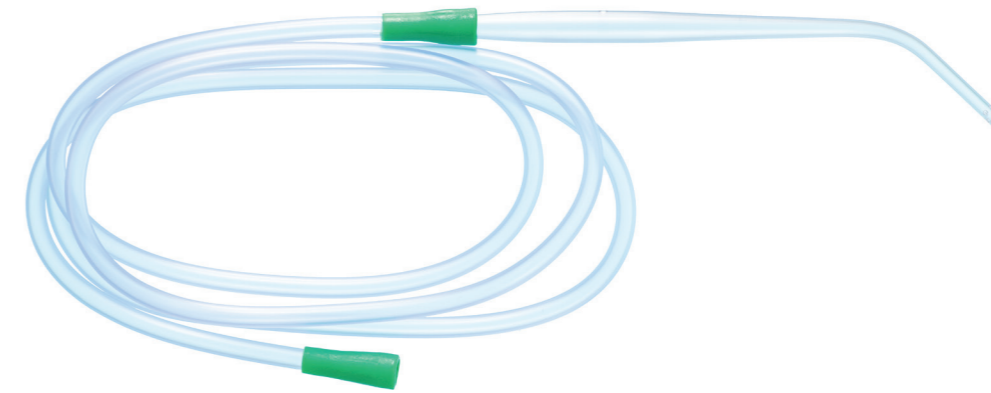

Our Link Yankauer Sets are pre-connected to Pennine Suction Connection Tubing in 2.0 and 3.0 metre lengths. For general purpose surgical suctioning.

- Sterile double wrapped in individual peel pouches
- Available with or without VC (vacuum control) vent

### Sets with 2m tubing

Product Code	Tubing Diam. /Length	Qty Per Box	Yankauer Type
LYS-5520	6mm / 2m	10	LY-3500 Mini Fine Tip
LYS-5620	6mm / 2m	10	LY-3600 Midi
LYS-5621	6mm / 2m	10	LY-3601 Midi VC
LYS-5720	6mm / 2m	10	LY-3700 Maxi
LYS-5721	6mm / 2m	10	LY-3701 Maxi VC
LYS-6620	7mm / 2.2m	10	LY-3600 Midi

### Sets with 3m tubing

Product Code	Tubing Diam. /Length	Qty Per Box	Yankauer Type
LYS-5430	6mm / 3m	10	LY-3400 Short Mini
LYS-5530	6mm / 3m	10	LY-3500 Mini Fine Tip
LYS-5531	6mm / 3m	10	LY-3501 Mini Fine Tip VC
LYS-5630	6mm / 3m	10	LY-3600 Midi
LYS-5631	6mm / 3m	10	LY-3601 Midi VC
LYS-5730	6mm / 3m	10	LY-3700 Maxi
LYS-5731	6mm / 3m	10	LY-3701 Maxi VC
LYS-6830	7mm / 3m	5	LY-3800 Maxi Plus
LYS-7730	8mm / 3m	5	LY-3700 Maxi



Want more information?  
Get in touch on +44 (0) 1332 794880 or email [customer.services@penninehealthcare.co.uk](mailto:customer.services@penninehealthcare.co.uk)



For more information on our product range please contact us on +44 (0) 1332 794880  
or alternatively send an email to [customer.services@penninehealthcare.co.uk](mailto:customer.services@penninehealthcare.co.uk)



## DERBY YANKAUERS

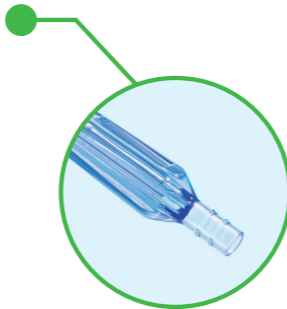
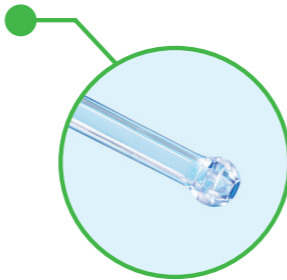

Our Derby Yankauers are clear, acrylic suction devices, similar to traditional yankauer suction probes. With or without sump tip to reduce potential tissue suction during use.

- Sterile double wrapped in individual peel pouches
- Available with or without VC (Vacuum control) vent
- Available with or without sump tip to reduce the risk of tissue damage
- Ergonomically shaped handle for a comfortable grip during use

Product Code	Type	Length	Diam.	CH	Qty per Box
* AEYS3004	with sump/rose tip	270mm	4.2mm	24CH	50
* AEYS3005	with sump/rose tip, VC	270mm	4.2mm	24CH	50
* AEYS3014	with straight/flat tip	270mm	4.2mm	24CH	50
* AEYS3015	with straight/flat tip, VC	270mm	4.2mm	24CH	50
YS-3000	Midi Yankauer with straight tip	265mm	6.66mm	20CH	50
YS-3001	Midi Yankauer with VC	265mm	6.66mm	20CH	50

## SELECTAVAC YANKAUERS

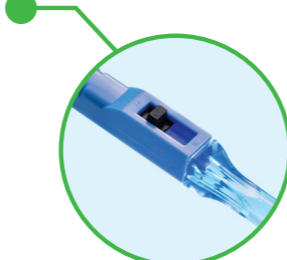
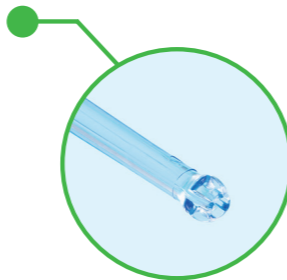

Our Selectavac Yankauers are surgical suction probe with switch on and off valve, available with bulb tip and straight tip.

- Switch system allows the operator to manually open and close suction
- Easy connection to Pennine range of tubing
- Supplied sterile, double wrapped in individual peel pouches

Product Code	Type	Length	Diam.	CH/Tip	Qty per Box
* AEYS3009	Bulb Tip, with On/Off Slide Switch	265mm	4.2mm	24CH	50
* AEYS3010	Straight Tip, with On/Off Slide Switch	265mm	4.2mm	24CH	50



For more information on our product range please contact us on +44 (0) 1332 794880 or alternatively send an email to [customer.services@penninehealthcare.co.uk](mailto:customer.services@penninehealthcare.co.uk)

## POOLE SUCTION PROBES

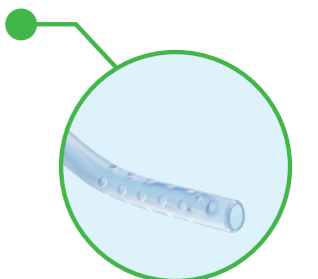
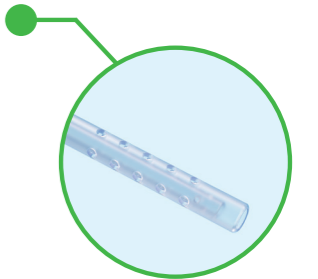
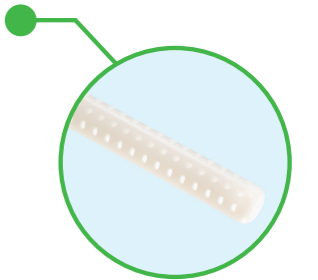

Our Poole Suction Probes are flexible or rigid 'sump' suction devices with removable inner suction probe and outer perforated sleeve. Used for general or abdominal suctioning and where larger volumes of fluids may need to be suctioned away without causing trauma to the surrounding tissues.

- Available with angled tip
- Sterile double wrapped in individual peel pouches
- Removable inner probe

Product Code	Type	Length	Inside Diam. mm	CH/Tip	Qty per Box
YS-3006	Flexible straight tip	300mm	6.66	20CH	50
YS-3008	Flexible angled tip	300mm	6.66	20CH	50
* AEYS3007	Rigid (white)	264mm	6.5	15CH	50



Want more information? Get in touch on +44 (0) 1332 794880 or email [customer.services@penninehealthcare.co.uk](mailto:customer.services@penninehealthcare.co.uk)

## POOLE SUCTION SETS

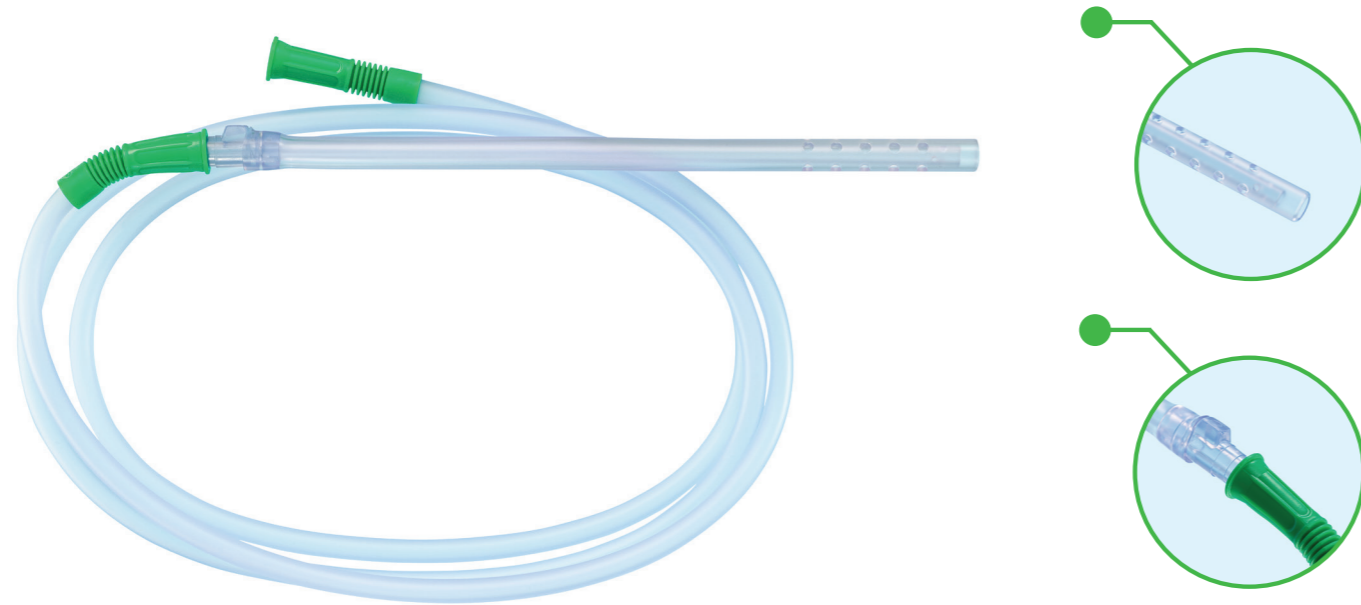

Our Poole Suction Sets are flexible and rigid 'sump' suction devices pre-attached to 2m or 3m connecting tube. Used for general or abdominal suctioning and where larger volumes of fluids may need to be suctioned away without causing trauma to the surrounding tissues.

- Sterile double wrapped in individual peel pouches

Set with 2m tubing	CH/Tip	Qty per Box	Tube Diam. mm	Poole Type
SYS-5920	20CH	10	6	YS-3006
SYS-5923	20CH	15	6	YS-3008
SYS-5930	20CH	10	6	YS-3006

## SUCTION PROBES

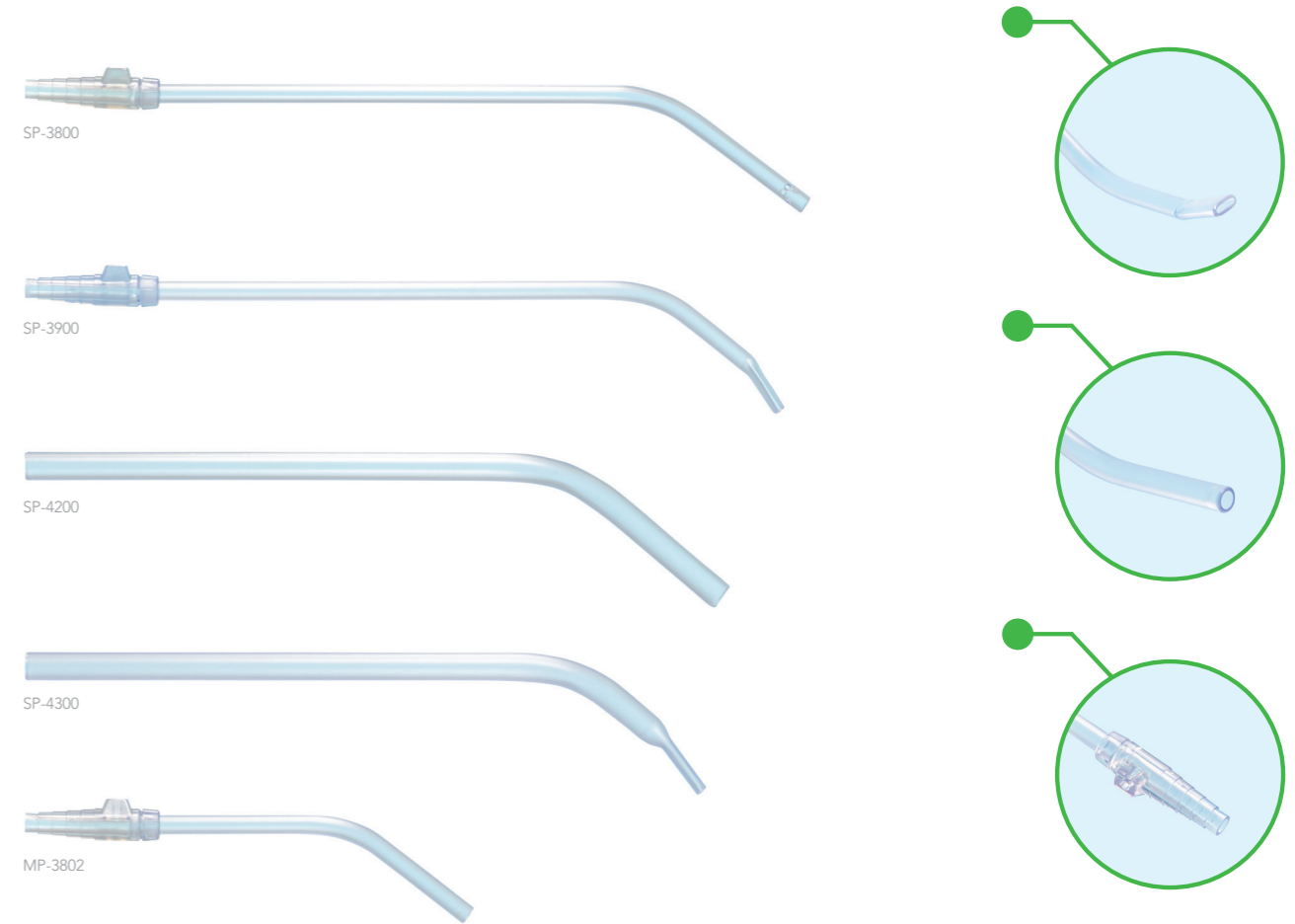

Our Suction Probes are manufactured from rigid transparent PVC, for general suction purposes in a wide variety of procedures. Easily attached to Pennine suction tubing.

- Sterile double wrapped in individual peel pouches
- Standard probes 20CH

Product Code	Type	Length	CH/Tip	Qty per Box
MP-3802	Short Suction Probe (no side eyes)	120mm	20CH	100
SP-3800	Suction probe with male connector	245mm	20CH	50
SP-3900	Flat tip probe with male connector	250mm	20CH	50
SP-4200	Maxi Suction Probe	280mm	30CH	50
SP-4300	Flat Tip Maxi Suction Probe	255mm	30CH	50



For more information on our product range please contact us on +44 (0) 1332 794880 or alternatively send an email to [customer.services@penninehealthcare.co.uk](mailto:customer.services@penninehealthcare.co.uk)



For more information on our product range please contact us on +44 (0) 1332 794880 or alternatively send an email to [customer.services@penninehealthcare.co.uk](mailto:customer.services@penninehealthcare.co.uk)

## SUCTION PROBE SETS

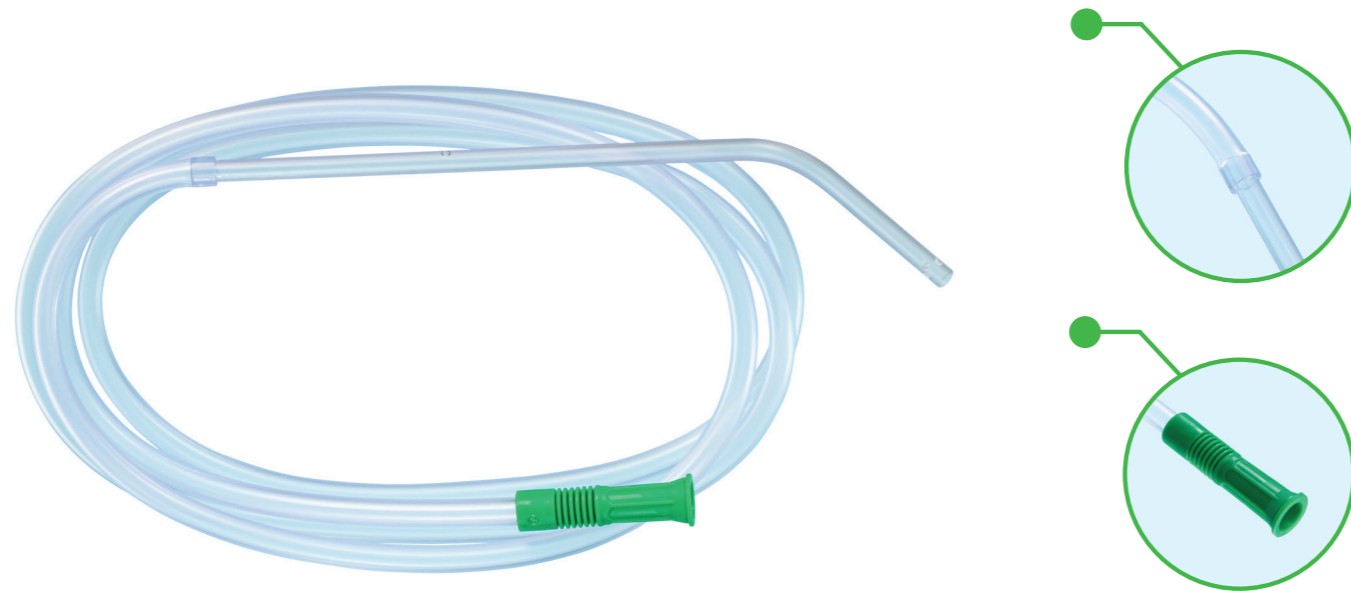

Our Suction Probe Sets are available pre-attached to 2m or 3m tubing. For general suction purposes in a wide variety of procedures.

- Sterile double wrapped in individual peel pouches
- Standard probes 20CH

### Sets with 2m tubing

Product Code	CH/Tip	Qty Per Box	Tube Diameter	Probe Type
SPS-5020/G	20CH	25	6mm	Standard Probe
SPS-5020/W	20CH	25	6mm	Standard Probe
SPS-5021	20CH	25	6mm	Standard Probe VC
SPS-6020	30CH	10	8mm	Maxi Probe

### Sets with 2.1m tubing

Product Code	CH/Tip	Qty Per Box	Tube Diameter	Probe Type
SPS-5022	20CH	50	6mm	Standard Probe

### Sets with 3m tubing

Product Code	CH/Tip	Qty Per Box	Tube Diameter	Probe Type
SPS-5030W	20CH	20	6mm	Standard Probe

## MICRO-FLEX SUCTION PROBES

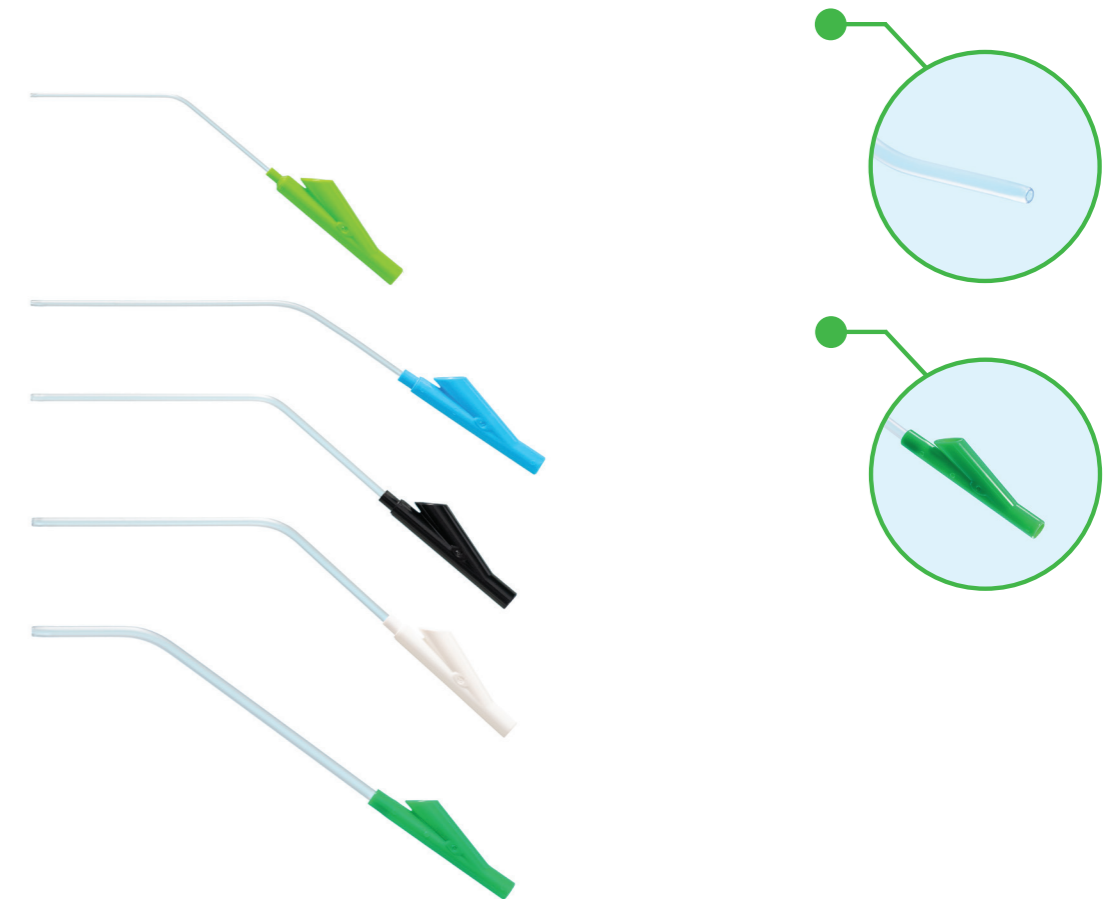

Our Micro-Flex Suction Probes are made from PVC and have a fingertip vacuum control. Designed for fine suctioning and in applications where controlled suction is required.

- Sterile double wrapped in individual peel pouches
- Colour coded fingertip vacuum control complies to ISO 5364:2016

Product Code	Length	CH/Tip	Qty per Box
YS-3148/14	16cm	14ch ø 4.66mm	50
YS-3128	15cm	12ch ø 4.00mm	50
YS-3108	15cm	10ch ø 3.33mm	50
YS-3088	15cm	8ch ø 2.66mm	50
YS-3008(Z)	11cm	8ch ø 2.66mm	50
YS-3068	11cm	6ch ø 2.00mm	50



For more information on our product range please contact us on +44 (0) 1332 794880 or alternatively send an email to [customer.services@penninehealthcare.co.uk](mailto:customer.services@penninehealthcare.co.uk)



For more information on our product range please contact us on +44 (0) 1332 794880 or alternatively send an email to [customer.services@penninehealthcare.co.uk](mailto:customer.services@penninehealthcare.co.uk)

## ENDO-FLEX SUCTION PROBES

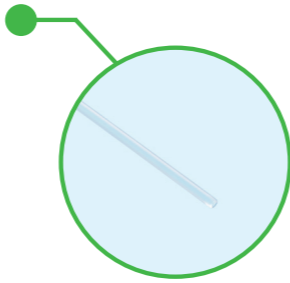
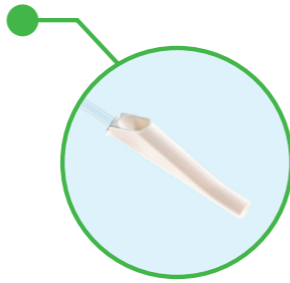

These Endo-Flex Suction Probes are used for general suction where longer probe length is required. All 12CH tubes with varying probe length. Fingertip vacuum control with tapered male connector end of presteril to fit Pennine connection tubing.

- Sterile double wrapped in individual peel pouches

Product Code	Length	CH/Tip	Qty per Box
YS-3128/20	29.8cm	12ch ø 4.00mm	10
YS-3128/26	35.8cm	12ch ø 4.00mm	10
YS-3128/40	49.8cm	12ch ø 4.00mm	10
YS-3128/60	69.8cm	12ch ø 4.00mm	10

## FRAZIER PROBES

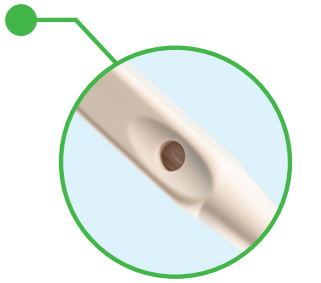
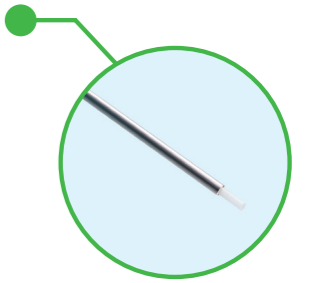

Our Frazier Probes are sterile single-use probes. With 'VC' vacuum control hole for precise control over the amount of suctioning. Used in open surgical procedures where delicate suctioning is required.

- Malleable shaft can be bent to desired position
- Sterile double wrapped in individual peel pouches
- Longer probe
- Longer, non-slip handle

Product Code	Length	CH/Tip	Qty per Box
* AEMF1108	230mm	8CH	40
* AEMF1110	230mm	10CH	40
* AEMF1112	230mm	12CH	40



We're here to help, please get in touch via telephone on +44 (0) 1332 794880 or email us at [customer.services@penninehealthcare.co.uk](mailto:customer.services@penninehealthcare.co.uk)



For more information on our product range please contact us on +44 (0) 1332 794880 or alternatively send an email to [customer.services@penninehealthcare.co.uk](mailto:customer.services@penninehealthcare.co.uk)

## EASYFLOW ORTHOPAEDIC SUCTION SET

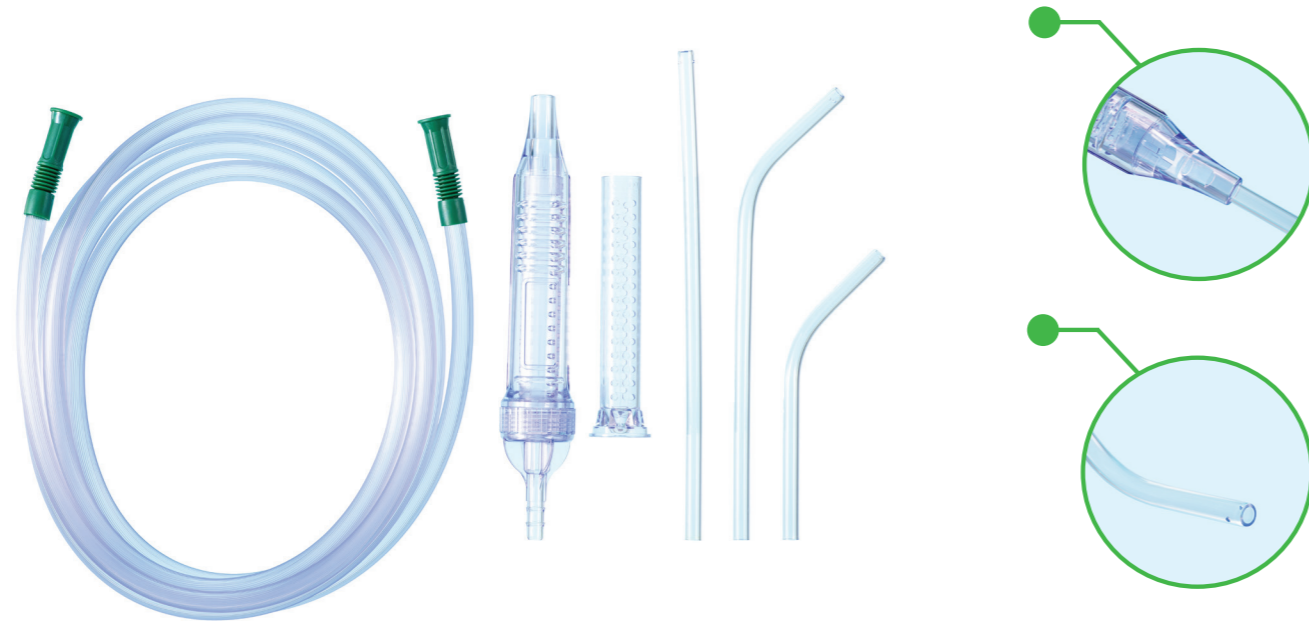

This Easyflow Orthopaedic Suction Set is a sterile filtered suction system for orthopaedic surgery.

- Suitable for removal of large bone fragments during orthopaedic surgery
- Eliminates blockages
- Rapid filter exchange
- Supplied sterile
- Ergonomic handle design ensures comfort and control
- Reversible suction tip provides extra length for intra-femoral suction

Product Code	Use	Contents	Qty per Box
* AEEFS1111	Orthopaedic Surgery	- 7mm/3m Flexi-Rib Tubing - 2 curved probes - 1 straight probe - Spare filter	10

## FLEXIBLE UTERINE CURETTES

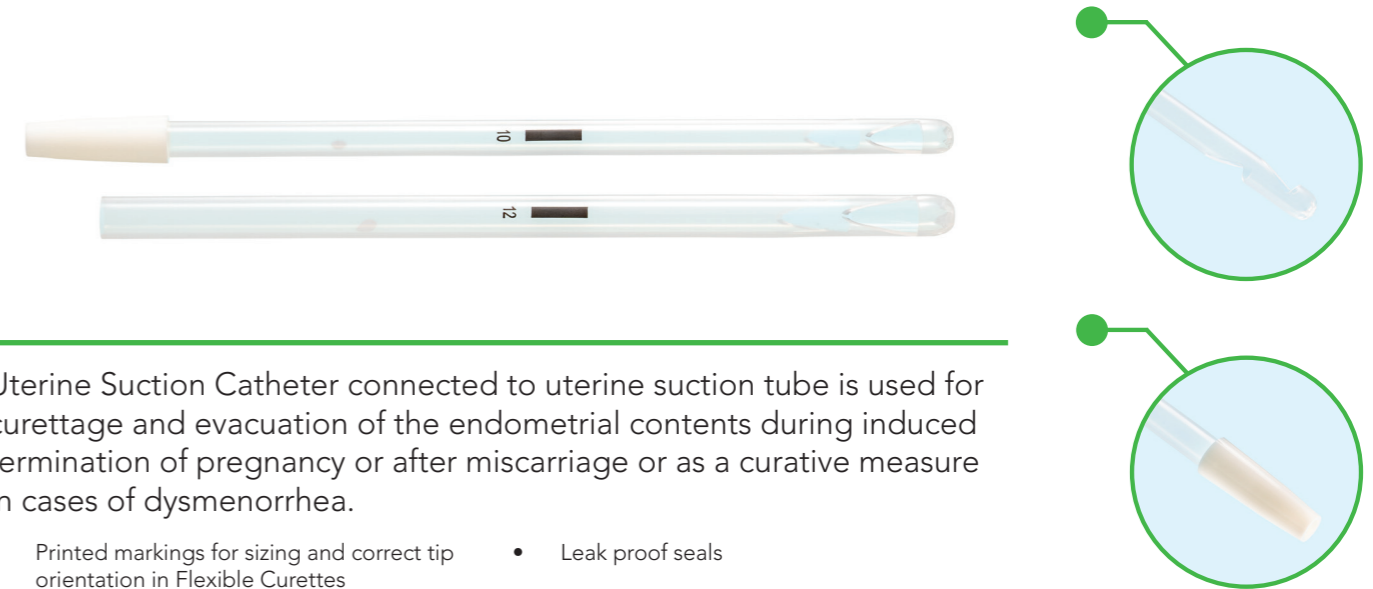

Uterine Suction Catheter connected to uterine suction tube is used for curettage and evacuation of the endometrial contents during induced termination of pregnancy or after miscarriage or as a curative measure in cases of dysmenorrhea.

- Printed markings for sizing and correct tip orientation in Flexible Curettes
- Sterile, double wrapped, individual peel pouches
- Leak proof seals

Product Code	Type	Diam. mm	Qty per Box
* AEAC3004	Flexible	4mm	50
* AEAC3005	Flexible	5mm	50
* AEAC3006	Flexible	6mm	50
* AEAC3007	Flexible	7mm	50
* AEAC3008	Flexible	8mm	50
* AEAC3009	Flexible	9mm	50
* AEAC3010	Flexible	10mm	50
* AEAC3011	Flexible	11mm	50
* AEAC3012	Flexible	12mm	50



For more information on our product range please contact us on +44 (0) 1332 794880 or alternatively send an email to [customer.services@penninehealthcare.co.uk](mailto:customer.services@penninehealthcare.co.uk)



We're here to help, please get in touch via telephone on +44 (0) 1332 794880 or email us at [customer.services@penninehealthcare.co.uk](mailto:customer.services@penninehealthcare.co.uk)

## UTERINE ASPIRATION CURETTES

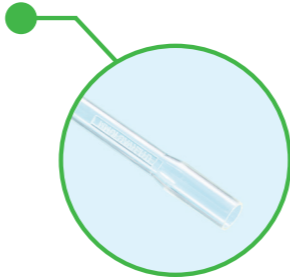
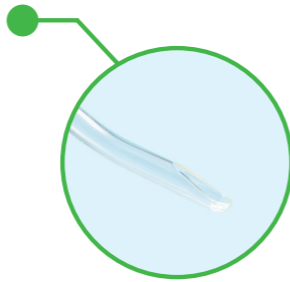
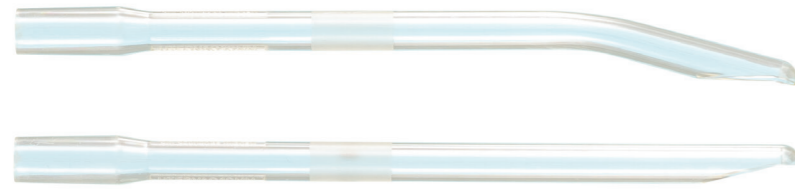

Uterine Suction Catheter connected to uterine suction tube is used for curettage and evacuation of the endometrial contents during induced termination of pregnancy or after miscarriage or as a curative measure in cases of dysmenorrhea.

- Curved and straight design for options in Rigid Curettes
- Moulded markings for sizing and correct tip orientation in Rigid Curettes
- Sterile, double wrapped, individual peel pouches
- Leak proof seals

Product Code	Type	Diam. mm	Qty per Box
* AEKC1506	Straight	6mm	50
* AEKC1507	Straight	7mm	50
* AEKC1508	Straight	8mm	50
* AEKC1509	Straight	9mm	50
* AEKC1510	Straight	10mm	50
* AEKC1511	Straight	11mm	50
* AEKC1512	Straight	12mm	50
* AEKC1006	Curved	6mm	50
* AEKC1007	Curved	7mm	50
* AEKC1008	Curved	8mm	50
* AEKC1009	Curved	9mm	50
* AEKC1010	Curved	10mm	50
* AEKC1011	Curved	11mm	50
* AEKC1012	Curved	12mm	50
* AEKC1514	Straight, with connector	14mm	30
* AEKC1014	Curved, with connector	14mm	30

## WIDE-BORE ASPIRATION TUBING (FLEXI-CUFF)

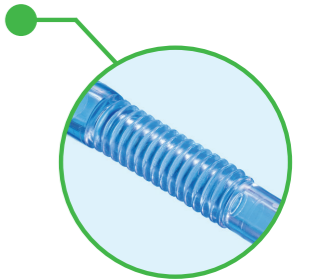
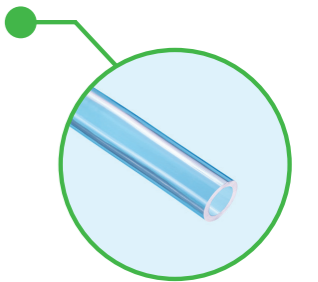
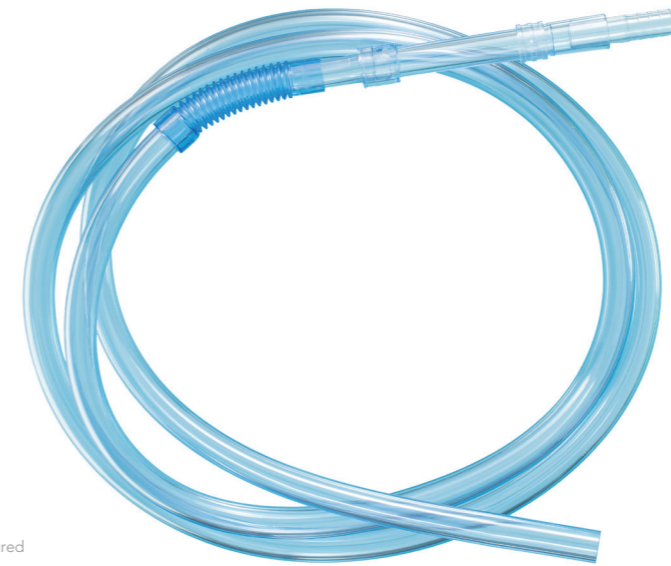

\*AEKHS3000M pictured

This Wide-Bore Aspiration Tubing (Flexi-Cuff) offers a convenient and adaptable system for uterine aspiration. It is frequently connected directly or through an external tube or catheter to an irrigator and/or aspirator for irrigation, infusion, or withdrawal of substances.

- Sterile double wrapped individual peel pouches
- Loose male connector in each pack for connection to suction machines where required
- Leak proof seals
- Tubing made of PVC
- Easily connects to curettes
- Flexi-Cuff provides extra flexibility at a crucial point offering ease of use and improved technique

Product Code	Type	Tubing Length	Qty per Box
* AEKHS3000	Wide Bore Tubing + Rotary Handle, loose male connector	2.0m	10
* AEKHS3000M	Wide Bore Tubing + Rotary Handle, attached male connector	2.0m	10
* AEKHS3030	Wide Bore Tubing + Rotary Handle, loose male connector	3.0m	10



For more information on our product range please contact us on +44 (0) 1332 794880 or alternatively send an email to [customer.services@penninehealthcare.co.uk](mailto:customer.services@penninehealthcare.co.uk)



For more information on our product range please contact us on +44 (0) 1332 794880 or alternatively send an email to [customer.services@penninehealthcare.co.uk](mailto:customer.services@penninehealthcare.co.uk)

# CAMERA COVER

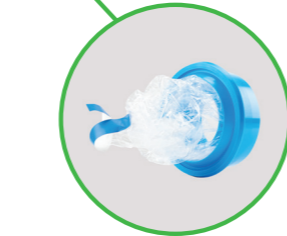
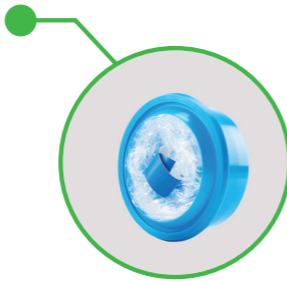
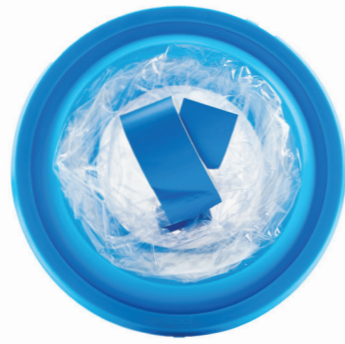

The disposable camera sleeve is a sterile, single-use disposable drape made of tough, thin polyethylene. The drape is the quickest and simplest way to create a sterile field for use with video/ camera systems during operative laparoscopic procedures. The tape used to secure the camera drapes is elastic and allows a secure and tight closure.

- Made of high grade special anti-blocking PE film
- One strip of adhesive tape
- Film stored in a ring.
- Supplied sterile

Product Code	Description	Size	Qty per Box
* E6222	Camera Cover, Open Tip, Ring Applicator	249cm x 15cm	64

# C-ARM DRAPE

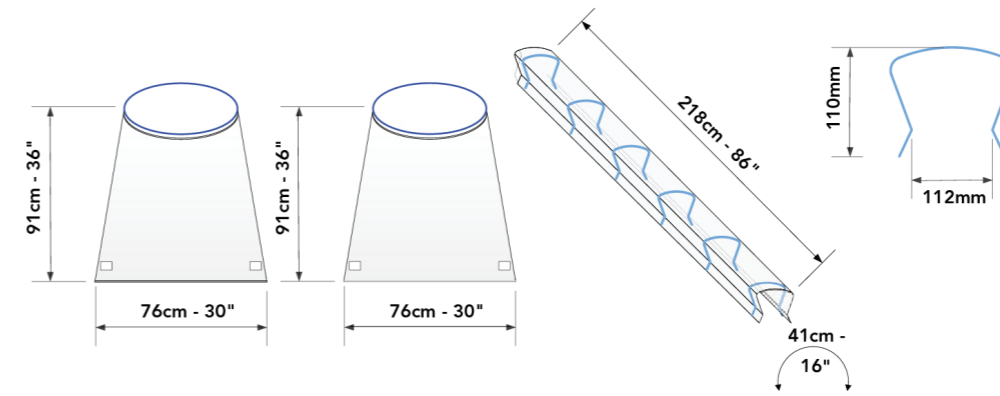

\*E6018 product drawing pictured

This 3-piece C-Arm drapes is designed to cover x-ray image intensifier equipment and protect the sterile field during surgical procedures.

- Two bonnet covers for the x-ray tank and image intensifier head
- Integral clips for secure fit

Product Code	Description	Size	Qty per Box
* E6016	C-Arm Kit V	76cm x 91cm, 224cm	20
* E6017	C-Arm Kit VI	79cm x 91cm, 224cm	20
* E6018	C-Arm Kit VII	76cm x 91cm, 218cm	20



We're here to help, please get in touch via telephone on +44 (0) 1332 794880 or email us at [customer.services@penninehealthcare.co.uk](mailto:customer.services@penninehealthcare.co.uk)



We're here to help, please get in touch via telephone on +44 (0) 1332 794880 or email us at [customer.services@penninehealthcare.co.uk](mailto:customer.services@penninehealthcare.co.uk)



---

Ivor Shaw Limited t/a Pennine Healthcare  
300 City Gate, London Road, Derby, DE24 8WY, UK.  
Tel: +44 (0)1332 794880  
[www.penninehealthcare.co.uk](http://www.penninehealthcare.co.uk)

 @arma\_health  Pennine Healthcare  @Pennine\_Health

BRO-7\_Rev\_3 04/2023